

## FIBERFORSTÆRKER F80-SERIE

Stort digitalt display og til lange afstande

F80R-PNP

Fiberfotocelle rødt LCD-display

- Stort digitalt display
- Lang afstand/hurtig reaktionstid
- Teach In-funktion



### PRODUKTBESKRIVELSE

F80-fiberforstærker har et stort, tydeligt display, der gør det nemt at aflæse det indkommende lys. Du kan vælge på forstærkeren, om du vil have lang detekteringsafstand eller hurtig reaktionstid. Indlæring sker med Teach In via den grønne knap på forstærkeren. Det er også muligt manuelt at ændre værdien på forstærkeren til hvilket niveau du ønsker dit udgangssignal.

### SPECIFIKATIONER

Effektforbrug	0,032 A
Elektrisk tilslutning	Indstøbt kabel 2m
Fotocelleteknik	Fiberforstærker
Funktion	Mørkkoblet/Lyskoblet
Godkendelser	CE
IP-klasse	IP40
Light / Dark Switching	Ja
Lystype	Rød LED
Reaktionstid	0,19 ms
Spænding DC max	24 V
Spænding DC min	12 V
Temperaturområde fra	-25 °C
Temperaturområde til	55 °C
Udgang	PNP
Udgangsstrøm max	0,1 A

- Response time
  - Long-distance mode **1.8ms**
  - High-speed mode **190μs**
- Sensing distance (with fibre optic cable FR105BC)
  - Long-distance mode **570mm**
  - High-speed mode **320mm**



Level indication, received light

### PNP-output

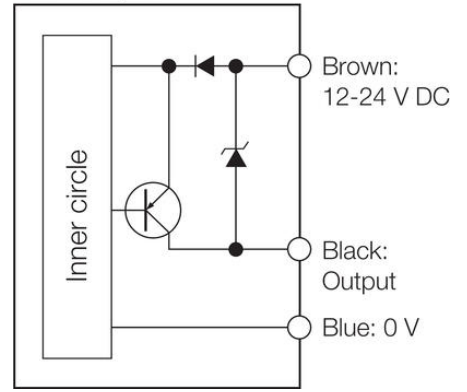

5 seconds

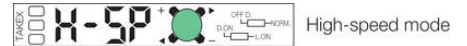
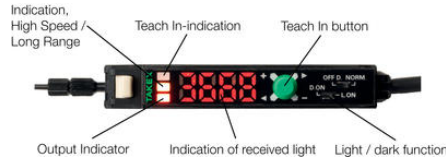
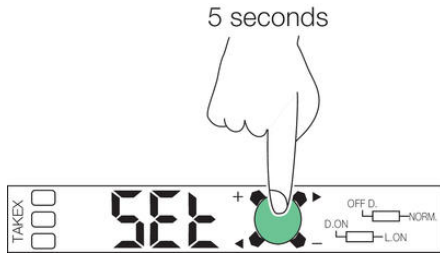

High-speed mode

3 seconds

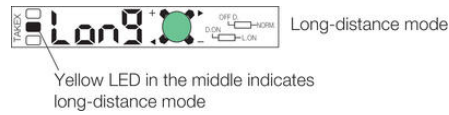
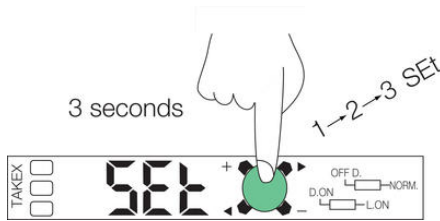

Long-distance mode

Yellow LED in the middle indicates long-distance mode



3 seconds

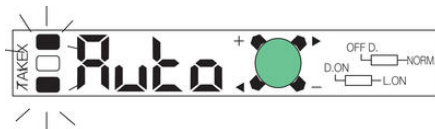
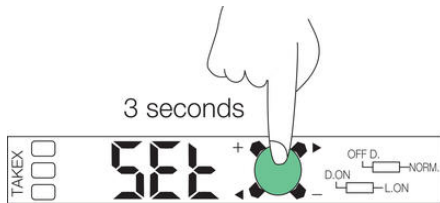

Level indication, received light

