

LUFTAKTIVERET 3/2-VEJS SÆDEVENTIL 1/2" - 2"

Serie E398

E398A001
Sædeventil 3/2 U RG 1/2" RS

- Alle flowretninger mulige. Også mixer funktion. (Universel)
- Meget solid ventil med arbejdstryk 0 til 40 bar
- Klarer medietemperaturer op til +250 °C.
- Klarer viskositet op til 5.000 cSt (mm²/s)
- Materiale i rustfrit stål og PTFE



PRODUKTBESKRIVELSE

Differenstryk	0-40 bar
Maks. tilladt tryk	40 bar
Maks. viskositet	5.000 cSt (mm ² /s)
Responstid	10-50 ms
Pilotmedie	Filterret luft
Maks. pilottryk	10 bar
Min. pilottryk	Se diagram eller tabel under fanen "DIMENSIONER"
Medietemperatur	-10 °C til +250 °C
Omgivelsestemperatur	-10 °C til +180 °C
Medie	Neutrale og aggressive medier Damp og overophedet vand
Design	
Ventilkrop	Rustfrit
Ventiltætning	Grafit
Stempelstangstætning	PTFE chevron
Stempelstang	Rustfrit
Stempel	Rustfrit
Stempeltætning	Bronze PTFE
Aktuator	Aluminium (Nikkelbeklædt)

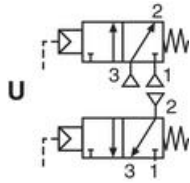

DIMENSIONER

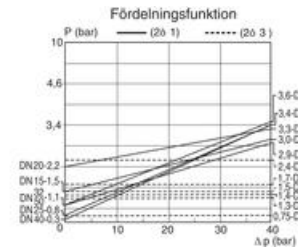
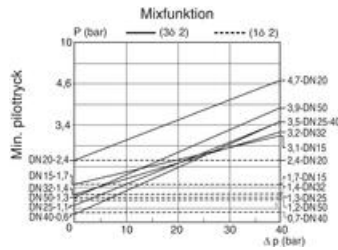
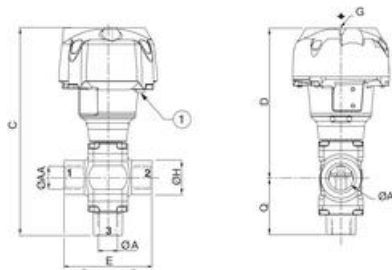

Ventil (ØAA)	ØA	ØB	C	D	E	G	ØH	ØP	Q	Vægt (kg)
1/2"	15	110	203.1	151.6	85	1/8	33	95	51.5	1.88
3/4"	20	132.5	229.2	170.9	110	1/8	40	117	58.3	3.52
1"	25	132.5	244.9	180.9	120	1/8	46	117	64	4.24
1 1/4"	32	191	318.2	237.2	145	1/4	57	172.5	81	9.38
1 1/2"	40	191	361.7	259.2	150	1/4	65	172.5	102.5	11.9
2"	50	247	436	328.5	190	1/4	75	230	107.5	23.66

BEST.NR.

Artikelnr.	Tilslutning	Lysning	Flow-faktor Kv				Pilottryk bar		Differenstryk bar		Aktuator mm
			Mixerfunktion	Fordelerfunktion			min.	maks.	min.	Vand/olie/damp	
Rustfrit ventilhus			(m³/h)	(m³/h)	(m³/h)	(m³/h)	min.	maks.	min.	Vand/olie/damp	mm
	G	mm									
U - Universel			3 → 2	1 → 2	2 → 3	2 → 1					
E398A001	1/2	15	3.3	4.4	3.5	4.6	*	10	0	40	80
E398A002	3/4	20	8.0	7.4	8.1	7.7	*	10	0	40	100
E398A003	1	25	11.4	11.6	12.1	11.9	*	10	0	40	100
E398A004	1 1/4	32	18.9	16.6	17.9	16.6	*	10	0	40	150
E398A005	1 1/2	40	27	27	27	27	*	10	0	40	150
E398A006	2	50	51	51	51	51	*	10	0	40	200

Mulighed for versioner med svejse- eller flangetilslutning.

(*) Min. pilottryk afhænger af differenstrykket, se diagram under fanen "DIMENSIONER".

SPECIELLE VERSIONER

- Pilotventil - SCG356A002VMS
- Flangetilslutning
- Svejsetilslutning

TILBEHØR

- Pilotventil

SPECIFIKATIONER

Differenstryk damp max	40 bar
Differenstryk luft max	40 bar
Differenstryk max	40 bar
Differenstryk min	0 bar
Differenstryk olie max	40 bar
Differenstryk vand max	40 bar
Funktion 1	3/2
Funktion 2	Universel
Gennemløb	15 mm
Godkendelser	SIL2
Materiale aktuator	Nikkelplateret aluminium
Materiale stempelstang	Rustfrit stål
Materiale stempeltætning	Bronze, PTFE
Materiale stuffing box	Rustfrit stål
Materiale stuffing box tætning	PTFE, karbonfyldt
Materiale tætninger	Grafit
Materiale ventilhus	Rustfrit stål 316L
Max tryk	40 bar
Medietemperatur fra	-10 °C
Medietemperatur til	250 °C
Styretryk max	10 bar
Temperaturområde fra	-25 °C
Temperaturområde til	180 °C
Tilslutning	1/2 BSP
Tilslutning luft	1/8 BSP
Type ventil	Sædeventil
Vægt	1,88 kg
Viskositet max	5000 cSt

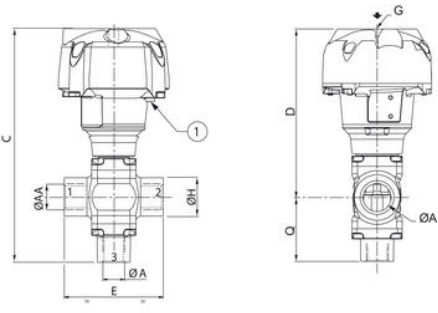
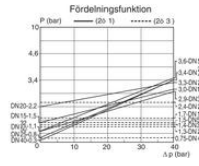
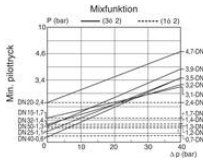

Ventil (ØAA)	ØA	ØB	C	D	E	G	ØH	ØP	Q
1/2"	15	110	203,1	151,6	85	1/8	33	95	51,5
3/4"	20	132,5	229,2	170,9	110	1/8	40	117	58,3
1"	25	132,5	244,9	180,9	120	1/8	46	117	64
1 1/4"	32	191	318,2	237,2	145	1/4	57	172,5	81
1 1/2"	40	191	361,7	259,2	150	1/4	65	172,5	102,5
2"	50	247	436	328,5	190	1/4	75	230	107,5